



Contact us :

Email: info@duonghung.vn

Website: www.duonghung.vn

Tel: (08) 7300 9948

Address: Số 36 Đường TL 57, Phường Thạnh Lộc, Quận 12, TP.HCM

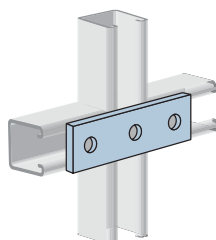
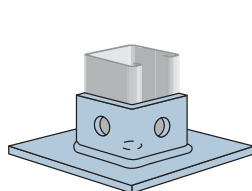
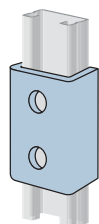
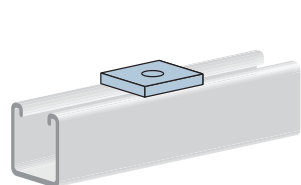
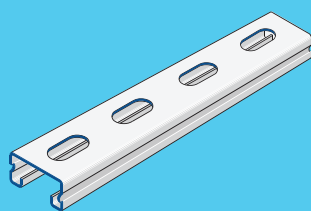
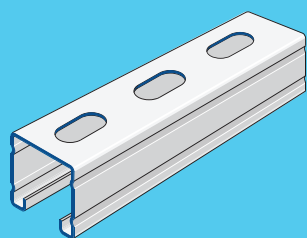
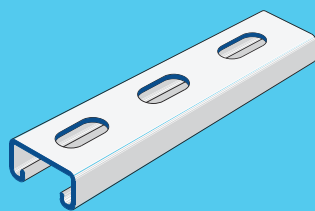
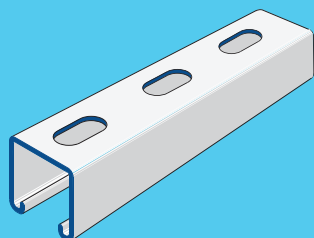
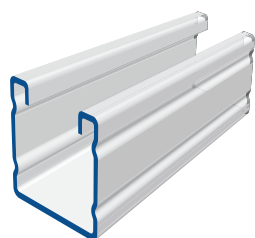
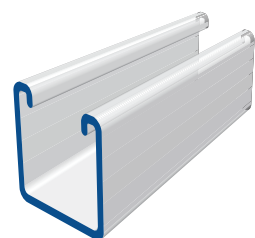

www.duonghung.vn

DHE

www.duonghung.vn
www.duonghung.vn

www.duonghung.vn
www.duonghung.vn

www.duonghung.vn
www.duonghung.vn

CATALOGUE

Support System

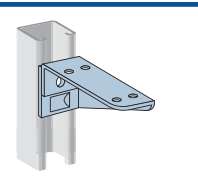

U_Channel and Fittings
www.duonghung.vn

2016

DHE

About Us

Corporate Information

Since 2013, Duong Hung is a professional design & manufacture electrical panel. Over 3 years, we are growing to become the leading of design & manufacture electrical panel in Vietnam.











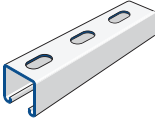

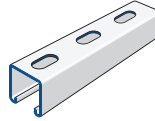
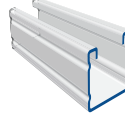
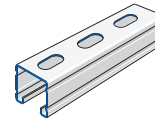
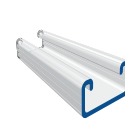
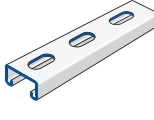

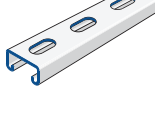

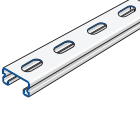

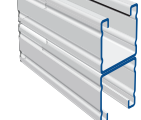
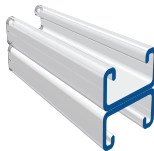

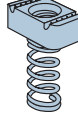

Our development policy

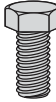
Long term cooperation and take transferred technology from the well-known companies. We commit to supply the quality products & professional services to customers.

Our Vision

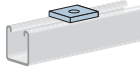
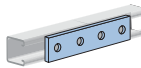
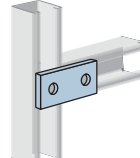
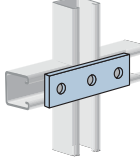
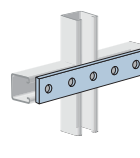
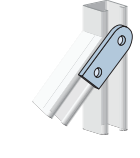
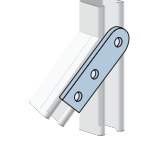
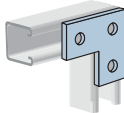
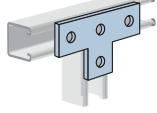
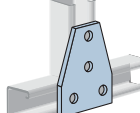
To be a leading of Switch board manufacturer in Vietnam and area.

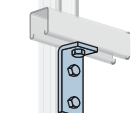
www.duonghung.vn

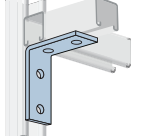
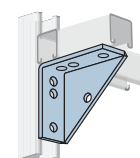
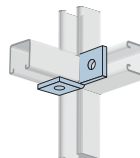
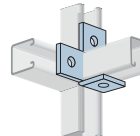
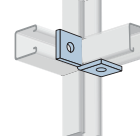
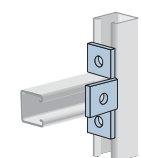
U_Channel System						
 4125 [GS/HG] Pg.08	 4125S [GS/HG] Pg.08	 4120 [GS/HG] Pg.09	 4120S [SGB/HG] Pg.09	 4115 [GS/HG] Pg.10	 4115S [GS/HG] Pg.10	 2125 [GS/HG] Pg.11
 2125S [GS/HG] Pg.11	 2120 [GS/HG] Pg.12	 2120S [GS/HG] Pg.12	 2115 [GS/HG] Pg.13	 2115S [GS/HG] Pg.13	 D4125 [GS/HG] Pg.14	 D4115 [GS/HG] Pg.14
 D2125 [GS/HG] Pg.15	 D2115 [GS/HG] Pg.15	 F41 Pg.16	 F21 Pg.16	 Nuts with long Springs Pg.16	 Nuts with short Springs Pg.16	 Nuts without Springs Pg.16
 Hex Head Set Screw Pg.16	 Hexagon Nuts Pg.16	 Flat Washers Pg.16	 Unirod Pg.17	 Rod Couplers Pg.17		
U_Channel System - Fittings						
 F0001 - 0004 Pg.17	 F0005 Pg.17	 F0006 Pg.17	 F0007 Pg.18	 F0008 Pg.18	 F0009 Pg.18	 F0010 Pg.18
 F0011 Pg.18	 F0012 Pg.18	 F0013 Pg.18	 F0014 Pg.18	 F0015 Pg.18	 F0016 Pg.18	 F0017 Pg.18
 F0018 Pg.18	 F0019 Pg.19	 F0020 Pg.19	 F0021 Pg.19	 F0022 Pg.19	 F0023 Pg.19	 F0024 Pg.19

U_CHANNEL PICTORIAL INDEX

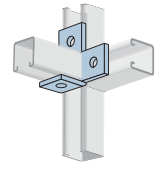
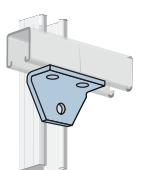
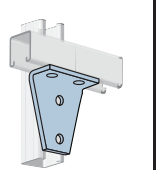
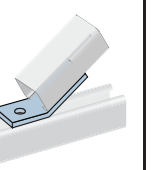
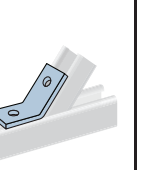
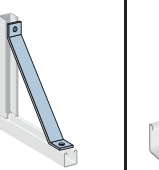
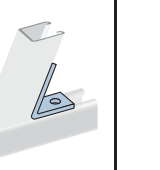
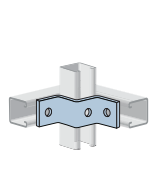
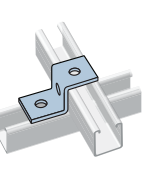
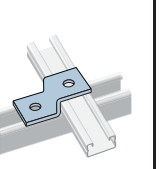
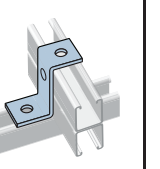
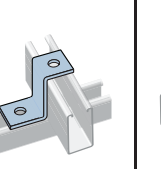
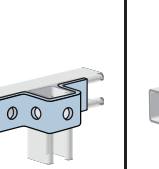
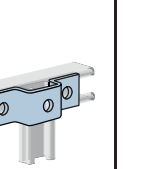
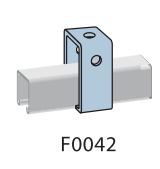
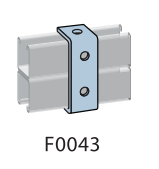
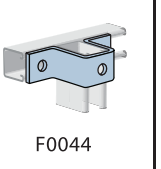
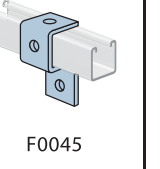
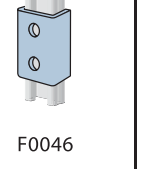
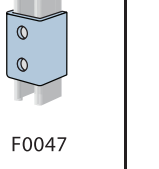
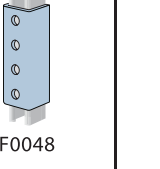
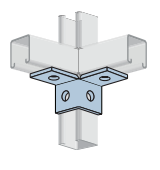
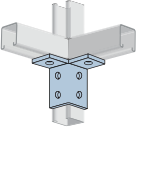
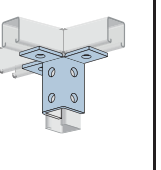
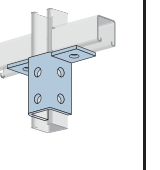
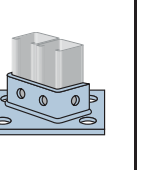
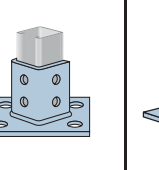
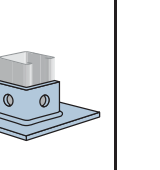
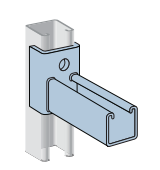
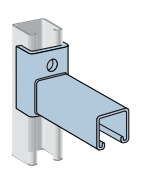
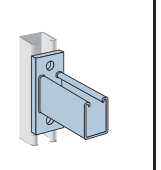
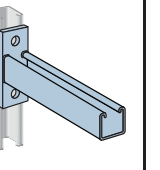
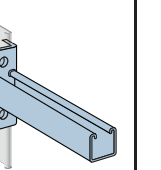
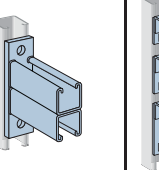
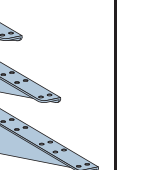
U_Channel System - Fittings						
 F0025 Pg.19	 F0026 Pg.19	 F0027 Pg.19	 F0028 - 0029 Pg.19	 F0030 - 0032 Pg.19	 F0033 Pg.19	 F0034 Pg.20
U_Channel System - Fittings (Con.t)						
 F0035 Pg.20	 F0036 Pg.20	 F0037 Pg.20	 F0038 Pg.20	 F0039 Pg.20	 F0040 Pg.20	 F0041 Pg.20
 F0042 Pg.20	 F0043 Pg.20	 F0044 Pg.20	 F0045 Pg.20	 F0046 Pg.21	 F0047 Pg.21	 F0048 Pg.21
 F0049 Pg.21	 F0050 Pg.21	 F0051 Pg.21	 F0052 Pg.21	 F0053 Pg.21	 F0054 Pg.21	 F0055 Pg.21
U_Channel System - Brackets & Beam Clamps						
 F0056 - 0057 Pg.22	 F0058 - 0059 Pg.22	 F0060 - 0063 Pg.22	 F0064 - 0067 Pg.22	 F0068 - 0069 Pg.23	 F0070 - 0074 Pg.23	 F0075 - 0082 Pg.23

ADJUSTABLE, DEMOUNTABLE, REUSABLE

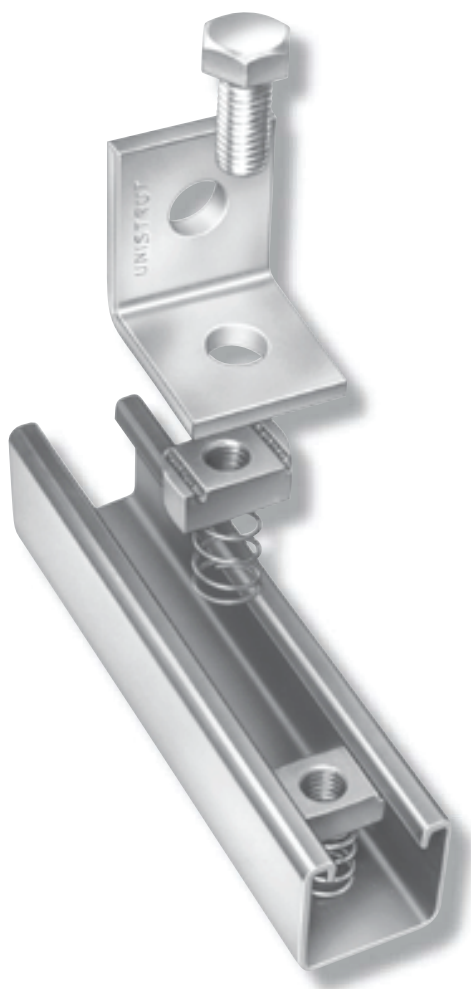

Spring nut is inserted anywhere along continuous slot. Rounded nut ends permit easy insertion.



A 90° turn positions the serrated grooves in the nut with the intumed edges of the channel.



Fittings may be placed anywhere along channel slot permitting complete freedom of adjustment. The need for drilling holes is eliminated.

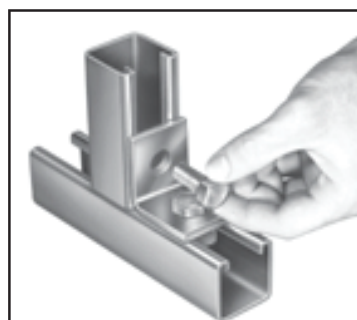

The fitting makes the connection between any framing channels or as means for other attachments.

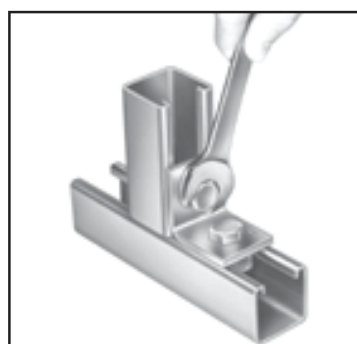

A turn of a spanner locks the serrated teeth of the nut into the intumed edges of the channel to make the strong, vice-like connection.

LOOK FOR THESE FEATURES:

Large chamfer in the nut eases starting of bolt.

Special shaped intumed edges and tapered, serrated grooves produce strong vice-like grip between channel and nut.

- ◆ Channel edges and nut's tapered grooves act as guides to provide positive alignment of connection.
- ◆ Nut teeth grip the channel's intumed edges, tying the channel sides together in a "box" configuration for added strength.
- ◆ Longitudinal movement of nut is resisted as hardened teeth bite into the intumed edges.

Spring allows precision placement anywhere along channel length, then holds nut in position while connection is completed - the installer's "third hand".

FRAMING MEMBERS

Channels and continuous inserts are accurately and carefully cold formed to size from low carbon strip steel. The channel has a continuous slot with inturned edges. Secure attachments may be made to the framing member with the use of hardened, toothed, grooved nuts which engage the inturned edges.

FITTINGS

The fittings, unless noted otherwise, are punch press formed from low carbon steel plates or strip.

CHANNEL NUTS

The DUONG HUNG nuts are produced from steel bars and after all manufacturing operations are completed, zinc plated nuts are case hardened. They are rectangular with the ends so shaped as to permit a quarter turn crosswise in the framing member after inserting through the slotted opening in the channel and to prevent any further turning of the nut. Two serrated grooves in the top of the nut engage the inturned edges of the channel and, after bolting operations are completed, will prevent any longitudinal movement of the bolt and nut within the framing member. All bolts and nuts have ISO metric coarse screw threads.

MASSES AND DIMENSIONS

Masses given for all material are approximate shipping weights. All dimensions subject to commercial tolerance variations.

Material

All single Unistrut Channel members are accurately and carefully rolled from strip steel to AS1594 and AS1365. Spot-welded combination members are welded 75mm (maximum) on centre. Some members may require fillet welding.

Standard Lengths

Standard lengths of the above channels are 5.8m. Facilities are available to cut standard lengths into any special lengths for a small cutting charge.

Section Shape

The roll forming process used by DUONG HUNG VIETNAM produces a consistent channel within the manufacturing tolerance allowed. The process includes stresses within the section itself which are released when the channel is cut. This creates a common condition known as "Bellmouth" where the section deforms slightly for a small distance in from the end.

FINISHES

All channels are available in Plain, Hot Dipped Galvanised, Galvabond, Zinc Plated and Polyester finishes.

Plain - Plain finish on DUONG HUNG channel is an oiled finish that is applied to the raw material by the steel mill. The cold rolling process used to form DUONG HUNG channel removes the excess of this oil and the residue provides a modicum of protection for the channel in storage. The plain finish on DUONG HUNG fittings is that of the commercial bar stock input material. No surface treatment is applied to plain finish fittings.

Galvabond Channe - Input material is supplied by the steel mill generally in accordance with AS1397 having a coating class of Z275. The material is slit to width and roll formed to shape.

Powder Coated - Channel and parts are carefully cleaned and phosphated. Immediately after phosphating, a uniform coat of thermosetting polyester powder is electrostatically applied then baked. Minimum coating thickness to exterior surfaces is 50 microns. The polyester coating is ultra-violet stabilised.

Hot Dipped Galvanised - Coatings are applied generally in accordance with AS/NZS4680. The thickness of the coating is dependent on the material thickness of the component being galvanised. It should be noted that due to the galvanising process, the thickness of the coating will vary over the surface and should be taken into account during component assembly. It may be necessary to remove excess build-up prior to use.

Zinc Plated - Channel, fittings and components are electroplated generally in accordance with AS1789. Fasteners are electroplated generally in accordance with AS1897 Service Condition 1.

Stainless Steel - DUONG HUNG stainless steel channel is manufactured from Grade 316 stainless steel. The material is slit to width and roll formed to shape. Grade 316 stainless steel has excellent corrosion resistance and has advantages over grade 304 stainless steel, such as:

- Resistance to pitting and crevice corrosion in chloride environments.
- Superior resistance to ordinary rusting in most applications.
- Regularly used in aggressive coastal and marine environments.
- Highly recommended for food processing environments where it can be easily cleaned and has a greater resistance to organic and inorganic chemical substances.

Aluminium - DUONG HUNG aluminium channels are manufactured from high strength alloy 6106-T6 for all extruded components and 5005 for sheet or plate components. These alloys are suitable for marine applications and offer excellent all round corrosion resistance.

Specific Coating - When specific applications require other commercially available finishes, they can be supplied according to specification.

We reserve the right to make specification changes without notice in the interest of improving our products.

Beams & Columns Loads

Notes to Table

Note 1: Loads are governed by shear or web crippling.
 Note 2: For uniform beam working loads asymmetric sections are required to be adequately braced to prevent rotation and twist.

Beam Loads

The loads and deflections shown are based on simply supported beams uniformly loaded.

Notes on Derivation of Structural Data

1. Section Properties

Section properties have been derived from 'as formed' shapes and are based on nominal dimensions and nominal base steel thickness. Nominal masses are calculated from the tabulated areas based on a steel density of 7850 kg per cu.m. For dead load calculations the tabulated masses should be increased by 10% to allow for rolling tolerances, and the result multiplied by 0.0098 to give corresponding dead load (self weight) in kN per m. run of section. Also note the beam and column loads do not make allowance for self weight of the section. When designing a structure in which the section forms an integral part, the self weight should be determined using the method described above and subtracted from the tabulated load.

2. Beam and Column Load Tables

Ultimate load values have been calculated from the section properties as permitted by AS/NZS 4600 Cold Formed Steel Structures code. The guaranteed minimum yield stress F_y has been taken as 210MPa for plain channels, and the increase allowed resulting from cold forming has been determined in accordance with the code. The listed working loads have been derived from the ultimate load divided by 1.5.

2.1 Span or Column Length

Listed value is to be taken as the distance between centres of supports.

2.2 Beam Load at Maximum Permissible Stresses

In order to establish the table of working loads that can be carried by the corresponding section, the ultimate limit state loads that could be permitted by the code were first determined. These were divided by 1.5 to provide 'conservative' working loads. The load is considered to be uniformly distributed along the span and orientated with respect to the section, as defined by the diagrams to cause bending about X-X axis only. The webs of the beams are

assumed to be unstiffened and have been checked for end bearing in accordance with clause 3.3.6 of AS/NZS4600:1996. Where this is critical the working loads have been appropriately reduced. This assessment has been based on a rigid support with the beam bearing on each support for a length equal to at least the straight length of web-depth of the basic section.

2.3 Deflection

Deflections are calculated for the corresponding beam working load, using standard formulae. Deflections or uniformly distributed loads for conditions other than those tabulated may be calculated from the following:

$$\delta_2 = (W2 / W1) \times (L2 / L1)^3 \times \delta_1$$

where:

- W1 = tabulated load in kN
- δ_1 = corresponding tabulated deflection in mm
- L1 = corresponding tabulated length in mm
- W2 = new load
- L2 = new length
- δ_2 = deflection corresponding to new length and new load

It is recommended that beam deflections generally be limited to the smaller of span/180 or 10mm and loads restricted accordingly. These limitations are based on 'visual straightness' with the latter value subject to variation to suit particular visual or other physical requirements.

2.4 Maximum Column Load

Listed values of colum load capacity are derived on the basis of a concentric axial load applied to the section, acting as a column with an effective length corresponding to the listed value, i.e. translational and torsional restraint available at the centres of supports. For other conditions of loading and/or restraint, reference should be made to the appropriate sections of AS/NZS 4600 Cold Formed Steel Structures.

3. Recommended Bearing & Connection Loads

Listed values are based on extensive testing of components by Duong Hung Vietnam Pty Limited using a factor of safety of 2.5 against failure of the connection.

4. Point Loads

For point loads at midspan, the allowable loads are half the values shown in the tables. The deflection for the point load is obtained from: $\delta_2 = 0.80 \times \delta_1$ where δ_1 is the deflection for a uniform load which is double the value of the point load.

FINISHES:

- AL Aluminium
- GS Galvanized Steel
- HG Hot Dipped Galvanized
- BS Black Steel
- SS Stainless Steel

MEASUREMENT:

- m metre
- mm Millimetre
- kg Kilogram

U_CHANNEL

4125 [GS/HG]

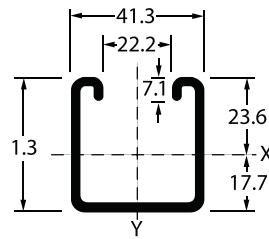
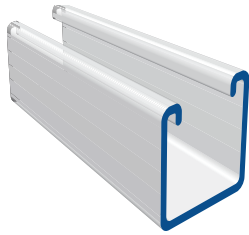

Mass: 2.63kg/m

Beam Span or Column Unsupported Height	Series.No	Uniform Beam Working Load	Concentrated Working Load	Max. Loading of column
mm		Kg	Kg	Kg
250	G4125	1,475.72	737.86	4,643.88
500	G4125	819.80	409.90	3,759.18
750	G4125	546.53	273.27	2,879.59
1000	G4125	409.39	204.69	2,187.76
1250	G4125	327.35	163.67	1,675.51
1500	G4125	273.27	136.63	1,346.94
1750	G4125	234.29	117.14	1,122.45
2000	G4125	204.18	102.09	954.08
2250	G4125	182.14	91.07	821.43
2500	G4125	163.16	81.58	715.31
2750	G4125	148.16	74.08	626.53
3000	G4125	136.12	68.06	550.00

4125S [GS/HG]

Slots 14 wide x 28 long at 56mm centres

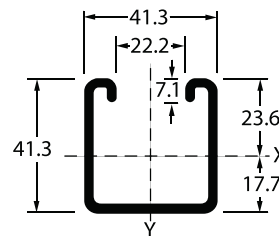
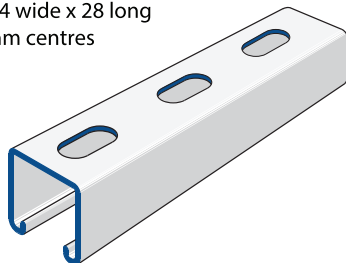

Mass: 2.32kg/m

Beam Span or Column Unsupported Height	Series.No	Uniform Beam Working Load	Concentrated Working Load	Max. Loading of column
mm		Kg	Kg	Kg
250	G4125S	1,362.24	681.12	4,179.59
500	G4125S	715.71	357.86	3,383.67
750	G4125S	476.79	238.39	2,591.84
1000	G4125S	357.86	178.93	1,969.39
1250	G4125S	286.07	143.04	1,508.16
1500	G4125S	237.86	118.93	1,212.24
1750	G4125S	204.64	102.32	1,010.20
2000	G4125S	177.86	88.93	858.16
2250	G4125S	158.57	79.85	738.78
2500	G4125S	142.50	71.25	643.88
2750	G4125S	129.64	64.82	564.29
3000	G4125S	120.00	60.00	502.00

4120 [GS /HG]

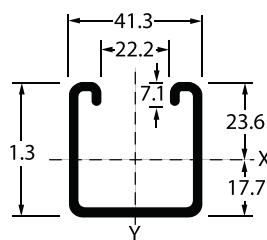
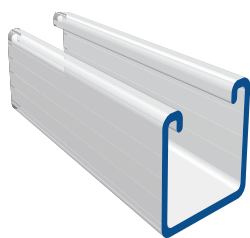

Mass: 2.1kg/m

Beam Span or Column Unsupported Height	Series.No	Uniform Beam Working Load	Concentrated Working Load	Max. Loading of column
mm		Kg	Kg	Kg
250	G4120	1,206.40	603.20	3,951.98
500	G4120	670.18	335.09	3,187.27
750	G4120	446.79	223.39	2,8306.12
1000	G4120	334.67	167.34	1,549.82
1250	G4120	267.61	133.80	1,084.03
1500	G4120	223.39	111.70	827.13
1750	G4120	191.53	95.76	667.47
2000	G4120	166.92	83.46	655.46
2250	G4120	148.90	74.45	482.59
2500	G4120	133.39	66.69	423.77
2750	G4120	121.12	60.56	376.95
3000	G4120	111.28	55.64	338.54

4120S [GS/HG]

Slots 14 wide x 28 long at 56mm centres

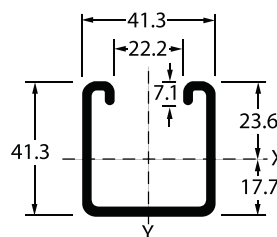
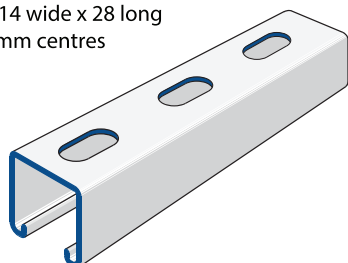

Mass: 1.85kg/m

Beam Span or Column Unsupported Height	Series.No	Uniform Beam Working Load	Concentrated Working Load	Max. Loading of column
mm		Kg	Kg	Kg
250	G4120S	1,106.79	553.40	3,625.67
500	G4120S	614.85	307.42	2,924.11
750	G4120S	409.90	204.95	2,115.71
1000	G4120S	307.04	153.52	1,421.85
1250	G4120S	245.51	122.76	994.53
1500	G4120S	204.95	102.47	758.84
1750	G4120S	175.71	87.86	612.36
2000	G4120S	153.14	76.57	601.34
2250	G4120S	136.61	68.30	442.75
2500	G4120S	122.37	61.19	388.78
2750	G4120S	111.12	55.56	345.83
3000	G4120S	102.09	51.05	310.58

4115 [GS/HG]

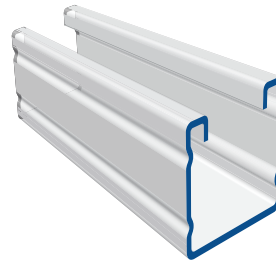
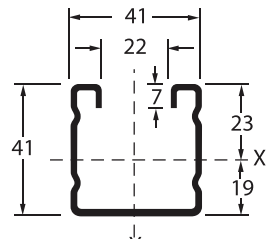

Mass: 1.58kg/m

Beam Span or Column Unsupported Height	Series.No	Uniform Beam Working Load	Conscentrated Working Load	Max. Loading of column
mm		Kg	Kg	Kg
250	G4115	958.28	479.14	3,062.79
500	G4115	563.81	281.90	2,470.14
750	G4115	375.87	187.94	1,787.24
1000	G4115	281.90	140.95	1,201.11
1250	G4115	225.15	112.58	840.13
1500	G4115	187.94	93.97	641.03
1750	G4115	160.95	80.48	517.29
2000	G4115	140.57	70.29	507.98
2250	G4115	125.60	62.80	374.01
2500	G4115	112.58	56.29	328.42
2750	G4115	102.34	51.17	292.14
3000	G4115	93.97	46.98	262.36

4115S [GS/HG]

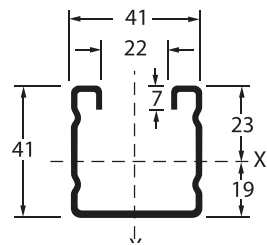

Slots 14 wide x 28 long as 56mm centres

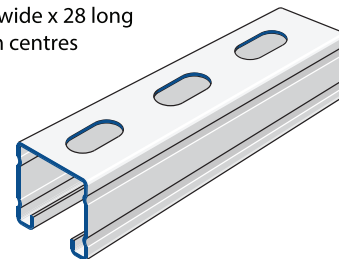

Mass: 1.39kg/m

Beam Span or Column Unsupported Height	Series.No	Uniform Beam Working Load	Conscentrated Working Load	Max. Loading of column
mm		Kg	Kg	Kg
250	G4115S	881.62	440.81	2,848.39
500	G4115S	518.70	259.35	2,297.23
750	G4115S	345.80	172.90	1,662.14
1000	G4115S	259.35	129.68	1,117.03
1250	G4115S	207.14	103.57	781.32
1500	G4115S	172.90	86.45	596.15
1750	G4115S	148.08	74.04	481.08
2000	G4115S	129.33	64.66	472.42
2250	G4115S	115.55	57.78	347.83
2500	G4115S	103.57	51.78	305.43
2750	G4115S	94.15	47.08	271.69
3000	G4115S	86.45	43.23	244.00

2125 [GS/HG]

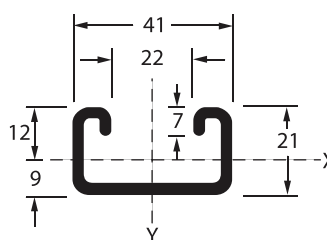
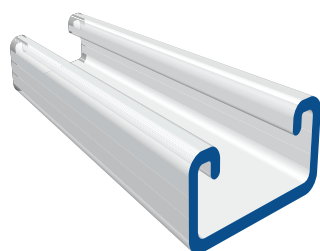

Mass: 1.84kg/m

Beam Span or Column Unsupported Height	Series.No	Uniform Beam Working Load	Concentrated Working Load	Max. Loading of column
mm		Kg	Kg	Kg
250	G2125	563.27	281.63	3,559.18
500	G2125	281.63	140.82	2,832.65
750	G2125	187.76	93.88	1,981.63
1000	G2125	140.82	70.41	1,232.65
1250	G2125	112.24	56.12	806.12
1500	G2125	93.88	46.94	567.35
1750	G2125	80.61	40.31	
2000	G2125	70.41	35.20	
2250	G2125	62.24	31.12	
2500	G2125	56.12	28.06	
2750	G2125	51.02	25.51	
3000	G2125	46.94	23.47	

G2125S [GB/HG]

Slots 14 wide x 28 long as 56mm centres

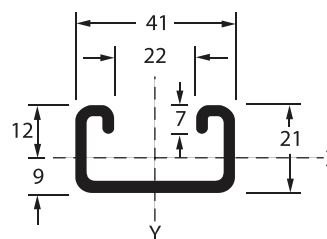
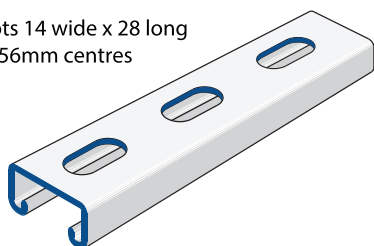

Mass: 1.62kg/m

Beam Span or Column Unsupported Height	Series.No	Uniform Beam Working Load	Concentrated Working Load	Max. Loading of column
mm		Kg	Kg	Kg
250	G2125S	525.45	262.73	3,203.06
500	G2125S	253.06	126.53	2,548.98
750	G2125S	169.39	84.69	1,783.67
1000	G2125S	126.53	63.27	1,109.18
1250	G2125S	101.02	50.51	725.51
1500	G2125S	84.69	42.35	510.20
1750	G2125S	72.45	36.22	
2000	G2125S	63.27	31.63	
2250	G2125S	56.12	28.06	
2500	G2125S	51.02	25.51	
2750	G2125S	45.92	22.96	
3000	G2125S	41.84	20.92	

U_CHANNEL

2120 [GS/HG]

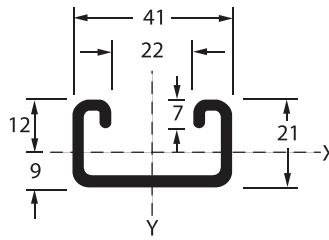

Mass: 1.48kg/m

Beam Span or Column Unsupported Height	Series.No	Uniform Beam Working Load	Concentrated Working Load	Max. Loading of column
mm		Kg	Kg	Kg
250	G2120	503.40	251.70	2,680.01
500	G2120	233.93	116.96	1,953.68
750	G2120	155.95	77.98	1,253.71
1000	G2120	116.96	58.48	783.87
1250	G2120	93.57	46.79	544.15
1500	G2120	77.98	38.99	401.52
1750	G2120	66.84	33.42	
2000	G2120	57.93	28.96	
2250	G2120	52.36	26.18	
2500	G2120	46.79	23.39	
2750	G2120	42.33	21.16	
3000	G2120	38.99	19.49	

G2120S [GB/HG]

Slots 14 wide x 28 long as 56mm centres

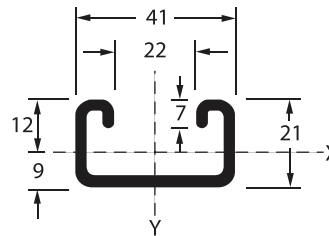
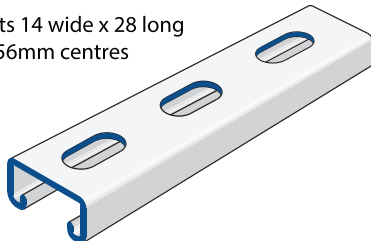

Mass: 1.31kg/m

Beam Span or Column Unsupported Height	Series.No	Uniform Beam Working Load	Concentrated Working Load	Max. Loading of column
mm		Kg	Kg	Kg
250	G2120S	445.58	222.79	2,372.17
500	G2120S	222.79	111.39	1,729.27
750	G2120S	148.53	74.26	1,109.70
1000	G2120S	111.39	55.70	693.83
1250	G2120S	89.12	44.56	481.65
1500	G2120S	74.26	37.13	355.40
1750	G2120S	63.65	31.83	
2000	G2120S	55.17	27.58	
2250	G2120S	49.86	24.93	
2500	G2120S	44.56	22.28	
2750	G2120S	40.31	20.16	
3000	G2120S	37.13	18.57	

2115 [GS/HG]

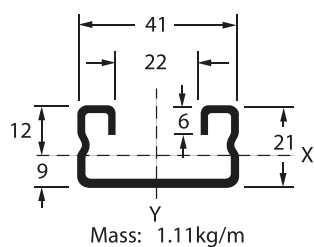

Beam Span or Column Unsupported Height	Series.No	Uniform Beam Working Load	Concentrated Working Load	Max. Loading of column
mm		Kg	Kg	Kg
250	G2115	396.43	198.21	2,110.09
500	G2115	198.21	99.11	1,538.52
750	G2115	132.14	66.07	986.88
1000	G2115	99.63	49.82	617.72
1250	G2115	79.71	39.85	428.94
1500	G2115	66.07	33.04	316.72
1750	G2115	56.63	28.32	
2000	G2115	49.29	24.65	
2250	G2115	44.05	2.202	
2500	G2115	39.85	19.93	
2750	G2115	35.66	17.83	
3000	G2115	33.56	16.78	

G2115S [GB/HG]

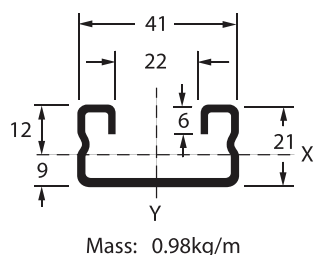

Slots 14 wide x 28 long as 56mm centres

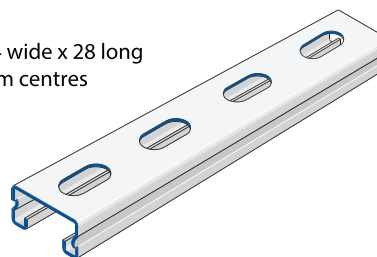

Beam Span or Column Unsupported Height	Series.No	Uniform Beam Working Load	Concentrated Working Load	Max. Loading of column
mm		Kg	Kg	Kg
250	G2115S	350.00	175.00	1,862.96
500	G2115S	175.00	87.50	1,358.33
750	G2115S	116.67	58.33	871.30
1000	G2115S	87.96	43.98	545.37
1250	G2115S	70.37	35.19	378.70
1500	G2115S	58.33	29.17	279.63
1750	G2115S	50.00	25.00	
2000	G2115S	43.52	21.76	
2250	G2115S	38.89	19.44	
2500	G2115S	35.19	17.59	
2750	G2115S	31.48	15.74	
3000	G2115S	29.63	14.81	

U_CHANNEL

D4125 [GS/HG]

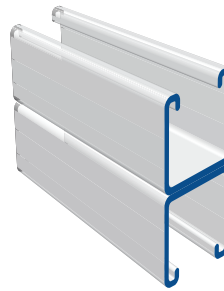
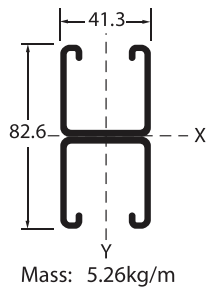

Beam Span or Column Unsupported Height	Series.No	Uniform Beam Working Load	Concentrated Working Load	Max. Loading of column
mm		Kg	Kg	Kg
250	D4125	2512.72	1256.36	9575.58
500	D4125	1918.84	959.42	9220.82
750	D4125	1279.88	639.94	8658.3
1000	D4125	959.42	479.71	7928.2
1250	D4125	767.34	383.67	306.74
1500	D4125	639.94	319.97	6163.22
1750	D4125	548.80	274.40	5233.2
2000	D4125	480.20	240.10	4332.58
2250	D4125	426.30	213.15	3490.76
2500	D4125	384.16	192.08	2827.3
2750	D4125	348.88	174.44	2337.3
3000	D4125	319.48	159.74	1963.92

D4115 [GS/HG]

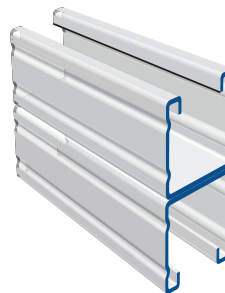
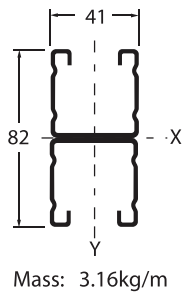

Beam Span or Column Unsupported Height	Series.No	Uniform Beam Working Load	Concentrated Working Load	Max. Loading of column
mm		Kg	Kg	Kg
250	D4115	1154.44	577.22	6942.32
500	D4115	1154.44	577.22	6681.64
750	D4115	1086.82	543.41	6268.08
1000	D4115	815.36	407.68	5733
1250	D4115	651.7	325.85	5110.7
1500	D4115	542.92	271.46	4441.36
1750	D4115	465.5	232.75	3762.22
2000	D4115	341.04	170.52	3113.46
2250	D4115	362.6	181.3	2497.04
2500	D4115	326.34	163.17	2022.72
2750	D4115	295.96	147.98	1671.88
3000	D4115	271.46	135.73	1404.34

D2125 [GS/HG]

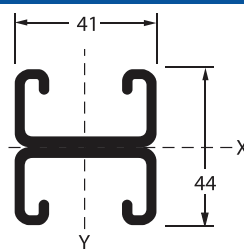
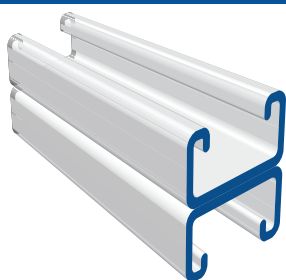

Mass: 3.68kg/m

Beam Span or Column Unsupported Height	Series.No	Uniform Beam Working Load	Concentrated Working Load	Max. Loading of column
mm		Kg	Kg	Kg
250	D2125	1526.84	763.42	7173.6
500	D2125	763.42	381.71	6597.36
750	D2125	508.62	254.31	5737.9
1000	D2125	382.2	191.1	4719.68
1250	D2125	305.76	152.88	3672.06
1500	D2125	254.8	127.4	2695
1750	D2125	218.54	109.27	1980.58
2000	D2125	191.1	95.55	1516.06
2250	D2125	169.54	84.77	1197.56
2500	D2125	152.88	76.44	
2750	D2125	139.16	69.58	
3000	D2125	127.4	63.7	

D2115 [GS/HG]

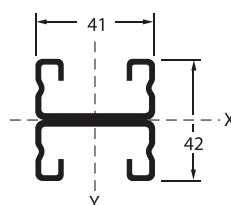
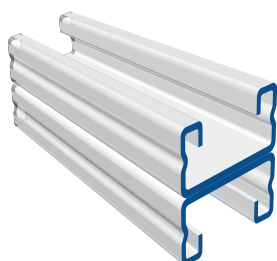

Mass: 2.22kg/m

Beam Span or Column Unsupported Height	Series.No	Uniform Beam Working Load	Concentrated Working Load	Max. Loading of column
mm		Kg	Kg	Kg
250	D2115	1018.22	509.11	4802
500	D2115	543.9	271.95	4410
750	D2115	362.6	181.3	3822
1000	D2115	272.44	136.22	3136
1250	D2115	217.56	108.78	2450
1500	D2115	181.3	90.65	1862
1750	D2115	155.82	77.91	1372
2000	D2115	136.22	68.11	980
2250	D2115	120.54	60.27	784
2500	D2115	108.78	54.39	
2750	D2115	98.98	49.49	
3000	D2115	91.14	45.57	

U_CHANNEL ACCESSORIES AND NUTS

Channel End Caps – Plastic, UV Stabilised

F21

Mass: 0.40kg/100

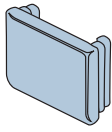

F41

Mass: 0.70kg/100

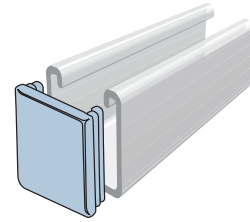

Typical Installation

Material

DUONG HUNG spring nuts are manufactured from steel bars, and after machining operations are completed, zinc plated nuts are case hardened. Hardening assures positive biting action into the inturned edge of the Unistrut channel. Similar nuts without springs are also available. Stud nuts are manufactured by welding studs to DUONG HUNG nuts except for USB series which are drop forged. Nuts and bolts are manufactured to AS1111&AS1112.

Threads – All threads on the nuts and bolts are metric coarse.

Design Bolt Torque – Refer to Engineering Data Page 118

Finishes –

Nuts and bolts are zinc plated to Australian Standards AS1897, selected sizes also available in hot dipped galvanised to AS1214.

Nuts with long Springs

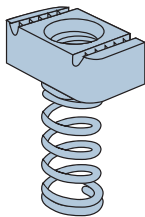

Size	Mass kg/100
M6	3.18
M8	3.18
M10	4.54
M12	5.45
M16	9.53

Nuts with short Springs

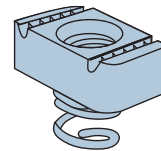

Size	Mass kg/100
M6	2.73
M8	2.73
M10	4.42
M12	3.65
M16	4.99

Hex Head Set Screws

Size	Mass kg/100
M6 x 20	0.6
M6 x 25	0.7
M6 x 30	0.8
M8 x 20	1.2
M8 x 25	1.4
M8 x 30	1.5
M8 x 40	1.8
M10 x 20	1.9
M10 x 25	2.1
M10 x 30	2.5
M10 x 40	3.0
M12 x 24	4.2
M12 x 30	4.5
M12 x 40	5.1
M12 x 60	7.5
M16 x 40	9.5

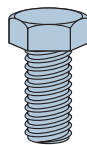

Nuts without Springs

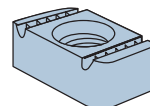

Size	Mass kg/100
M6	1.00
M6	2.72
M8	2.72
M10	4.41
M12	3.64
M16	9.08

Hexagon Nuts

Size	Mass kg/100
M6	0.2
M8	0.5
M10	0.8
M12	1.8
M16	3.3
M20	5.6

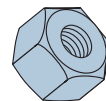

Flat Washers

Size	Mass kg/100
M6	0.1
M8	0.1
M10	0.3
M12	0.4
M16	0.8
M20	0.9



Unirod

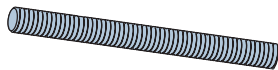

Size	Max. Recommended Tensile Load (kg)	Mass kg/100
M6	315.56	0.20
M8	572.32	0.35
M10	909.44	0.50
M12	1321.04	0.80
M12	2461.76	1.30
M12	3841.60	2.10

Standard Finish: Zinc Plated.
 *Also available in Hot Dipped Galvanised.
Standard Length: 3m
Unirod Load Data: Maximum recommended tensile load is based on a safety factor of 2.5 using the appropriate stress area of thread and ultimate tensile strength of 430 MPa.

Rod Couplers

Size	Length 'A'	Mass kg/100
M6	20	1.2
M8	20	2.3
M10	30	4.0
M12	40	7.8
M16	50	12.2
M20	50	19.0

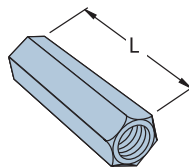

Standard Finish: Zinc Plated.
 *Also available in Hot Dipped Galvanised.

Fittings - General Information

Material

Unless otherwise noted, all fittings are punch press formed from plate or strip steel.

Fitting Application

All product drawings illustrate only one application of each fitting. In most cases many other applications are possible.

The members shown in the illustrations are P1000, 41mm square, except where noted otherwise. All 14mm diameter holes use M12 x 24 hex head set screws and M12 nuts - P1010, P4010 or P5510 - depending on the channel used. Nuts and bolts are not included with the fitting and must be ordered separately.

Design Load Data

Design load data, where shown, is based on the ultimate strength of the connection with a safety factor of 2.5.

Design Bolt Torque

Refer to Engineering Data (See Page 118).

Finishes

All fittings in this section are available in zinc plated finish to Australian Standard AS1789 and Hot Dipped Galvanised to AS/NS4680.

F0001 - 0004

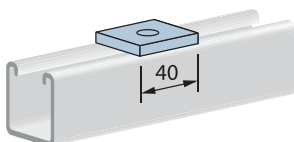

Bolt Size	Hole Size	Mass kg/100
8	9	7.0
10	12	6.8
12	14	6.6
16	18	6.4

F0005

Mass: 32kg/100

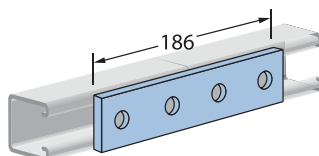

F0006

Mass: 16kg/100

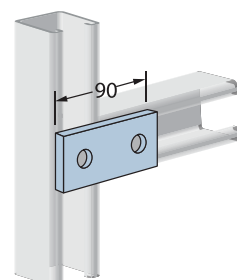

U_CHANNEL FITTINGS - FLAT PLATE

F0007

Mass: 24kg/100

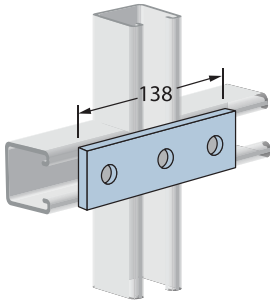

F0008

Mass: 41kg/100

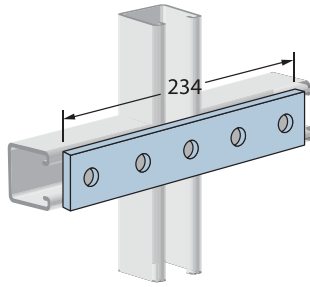

F0009

Mass: 23kg/100

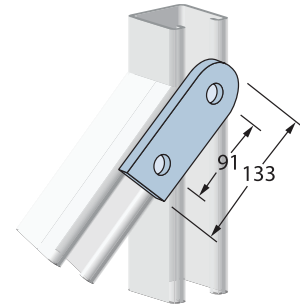

F0010

Mass: 31kg/100

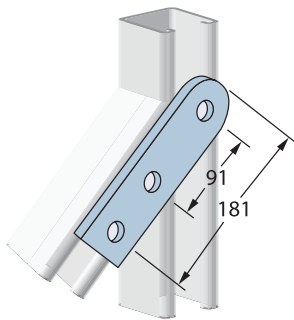

F0011

Mass: 25kg/100

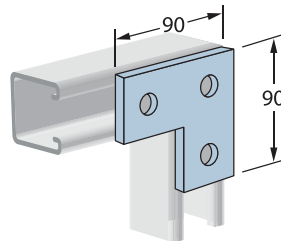

F0012

Mass: 35kg/100

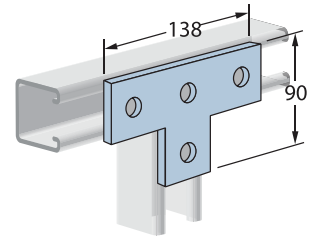

F0013

Mass: 48kg/100

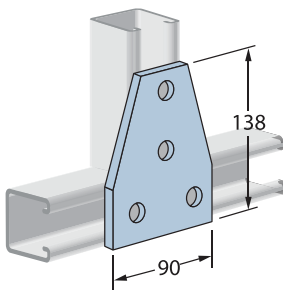

F0014

Mass: 17kg/100

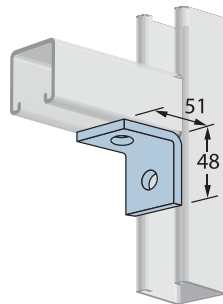

F0015

Mass: 17kg/100

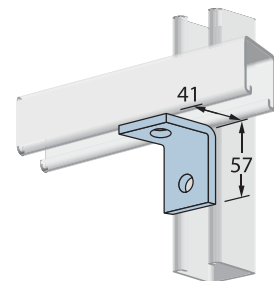

F0016

Mass: 24kg/100

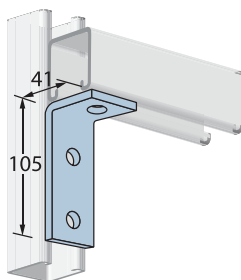

F0017

Mass: 24kg/100

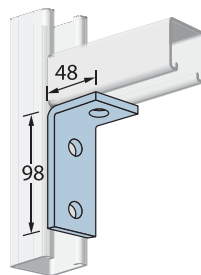

F0018

Mass: 24kg/100

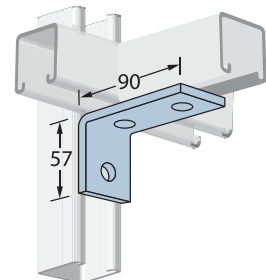

Standard Dimensions for 41mm width series channel fittings (Unless Otherwise Shown on Drawing)

U_CHANNEL FITTINGS - FLAT PLATE & 90° ANGLE

F0019

Mass: 33kg/100

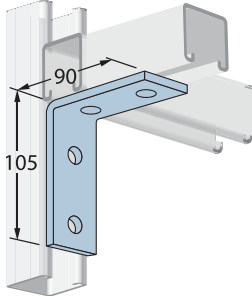

F0020

Mass: 61kg/100

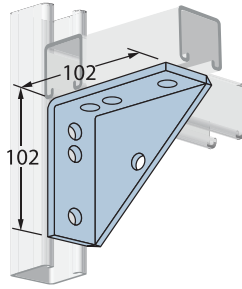

F0021

Mass: 25 kg/100

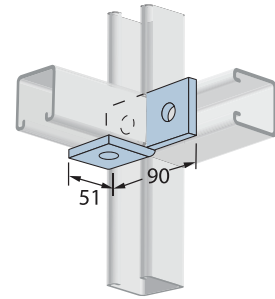

F0022

Mass: 35kg/100

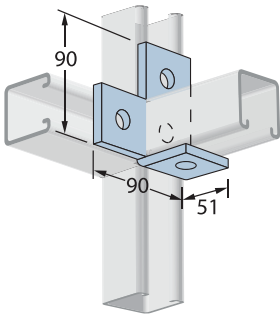

F0023

Mass: 25kg/100

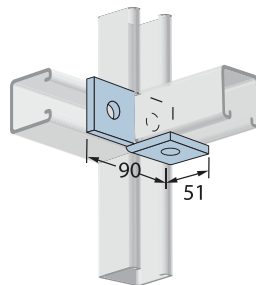

F0024

Mass: 35kg/100

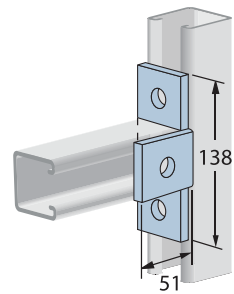

F0025

Mass: 35kg/100

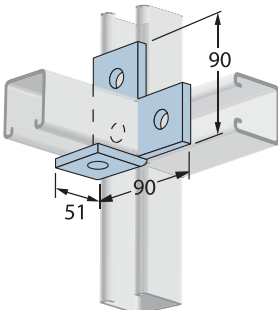

F0026

Mass: 32kg/100

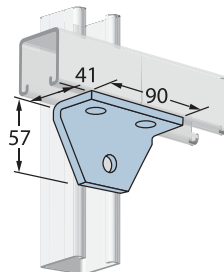

F0027

Mass: 48kg/100

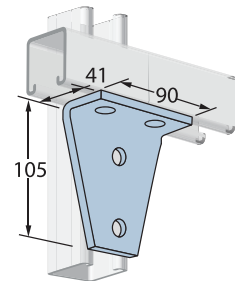

F0028 - 0029

Mass: 26kg/100

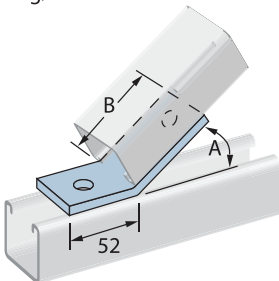

A	B
30	83
15	84

F0030 - 0032

Mass: 26kg/100

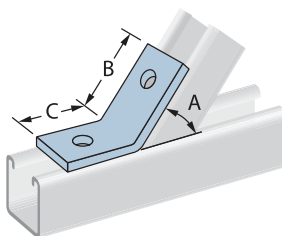

A	B	C
75	91	43
60	86	48
45	76	60

F0033

Mass: 103kg/100

Design Axial Load - 5.36kN

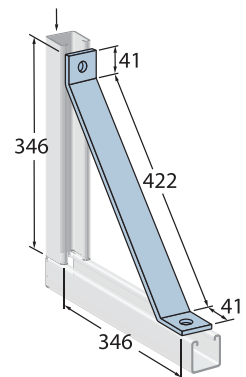

Standard Dimensions for 41mm width series channel fittings (Unless Otherwise Shown on Drawing)

U_CHANNEL FITTINGS - 90°, ANGULAR & "Z" SHAPE

F0034

Mass: 26kg/100

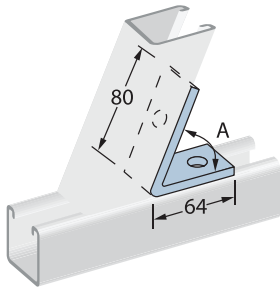

F0035

Mass: 27kg/100

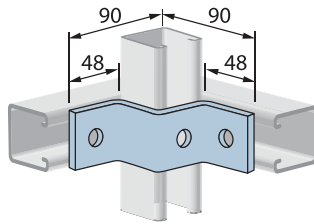

F0036

Mass: 24kg/100

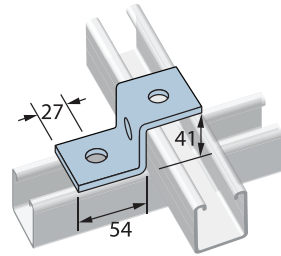

F0037

Mass: 20kg/100

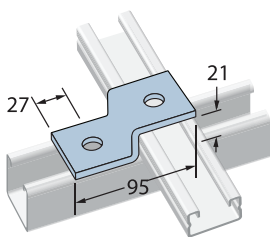

F0038

Mass: 30kg/100

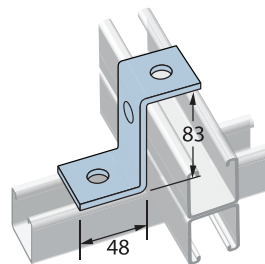

F0039

Mass: 29kg/100

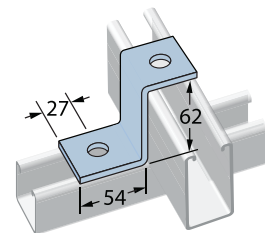

F0040

Mass: 37kg/100

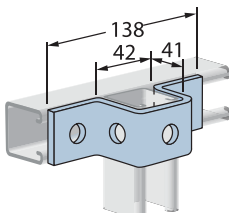

F0041

Mass: 30kg/100

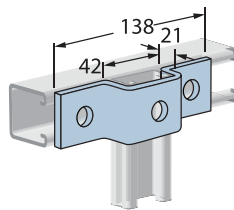

F0042

Mass: 47kg/100

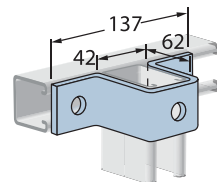

F0043

Mass: 46kg/100

M10 x 70

bolt and nut included

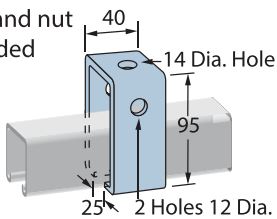

F0044

Mass: 30kg/100

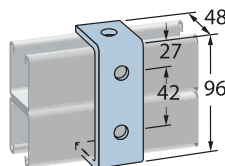

F0045

Mass: 35kg/100

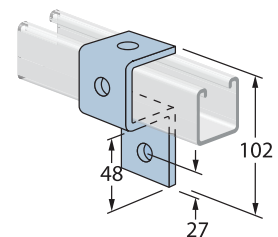

Design Load: 523.32kg
Channel Trolley Support

Standard Dimensions for 41mm width series channel fittings (Unless Otherwise Shown on Drawing)

U_CHANNEL FITTINGS - "Z" & "U" SHAPE

F0046

Mass: 38kg/100

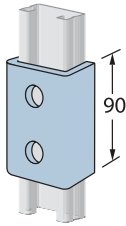

F0047

Mass: 56kg/100

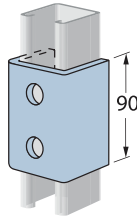

F0048

Mass: 115kg/100

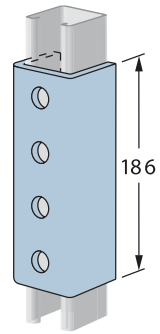

F0049

Mass: 34kg/100

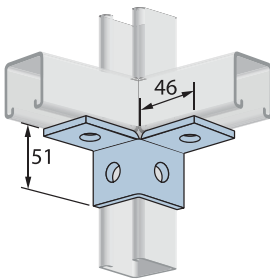

F0050

Mass: 50kg/100

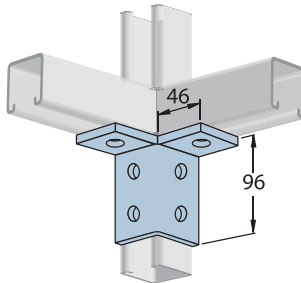

F0051

Mass: 78kg/100

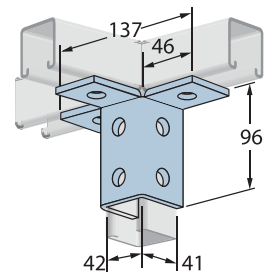

F0052

Mass: 66kg/100

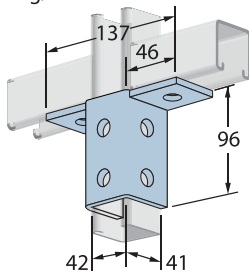

F0053

Mass: 140kg/100

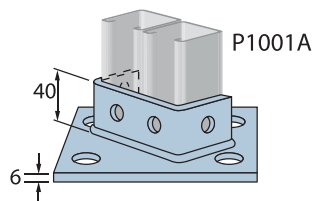

F0054

Mass: 164kg/100

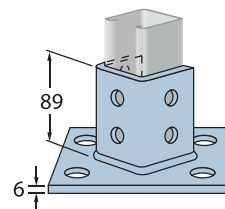

F0055

Mass: 62kg/100

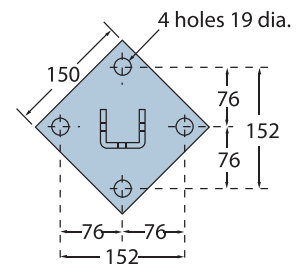
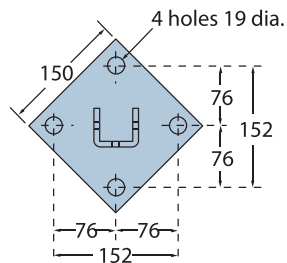
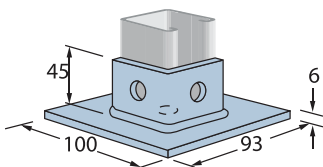

Standard Dimensions for 41mm width series channel fittings (Unless Otherwise Shown on Drawing)

U_CHANNEL - BRACKETS

Brackets - General Information

Material

Unless otherwise noted, all fittings are punch press formed from plate or strip steel.

Fitting Application

All product drawings illustrate only one application of each fitting. In most cases many other applications are possible.

The members shown in the illustrations are P1000, 41mm square, except where noted otherwise. All 14mm diameter holes use M12 x 24 hex head set screws and M12 nuts - P1010, P4010 or P5510 - depending on the channel used. Nuts and bolts are not included with the fitting and must be ordered separately.

Design Load Data

Loadings are as shown based on calculations in accordance with AS/NZS 4600 and AS 4100.

Design Bolt Torque

Refer to Engineering Data (See Page 07).

Finishes

All fittings in this section are Hot Dipped Galvanised to AS/NZS4680 unless otherwise shown.

Standard Dimensions

The following dimensions apply to all fittings except as noted on the individual part drawings:

- Hole Size - 14mm diameter
- Hole Spacing - 21mm from end
- Hole Spacing - 48mm from centre
- Width - 40mm
- Thickness - 6mm

F0056 - 0057

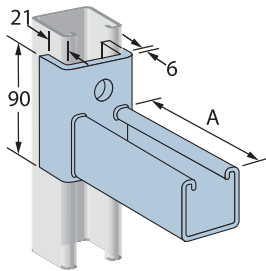

A	Design Uniform Load kN	Mass kg/100
152	633.08	81
305	370.44	124

F0058 - 0059

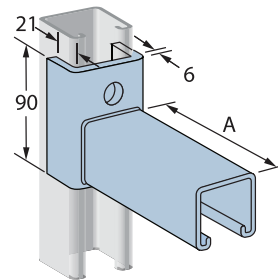

A	Design Uniform Load kN	Mass kg/100
152	633.08	81
305	370.44	124

F0060 - 0063

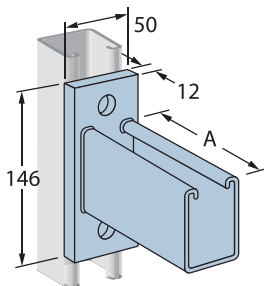

A	Design Uniform Load kg	Mass kg/100
300	679.14	173
450	468.44	224
600	354.76	276
750	285.18	327

F0064 - 0067

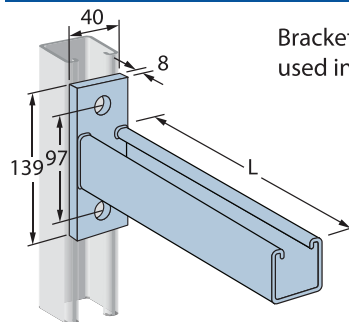

Brackets can be used inverted

A	Design Uniform Load - kg	Mass kg/100
250	294.98	102
400	184.24	143
550	133.28	186
700	103.88	229

Standard Dimensions for 41mm width series channel fittings (Unless Otherwise Shown on Drawing)

U_CHANNEL - ADJUSTABLE BRACE FITTINGS & BRACKETS

F0068 - 0069

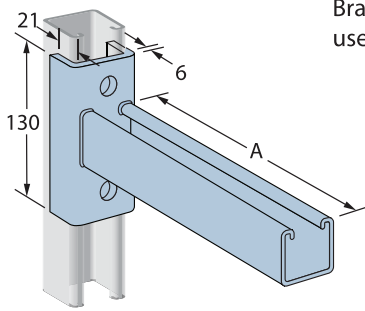

Brackets can be used inverted

A	Design Uniform Load - kg	Mass kg/100
457	307.72	189
610	193.06	232

F0070 - 0074

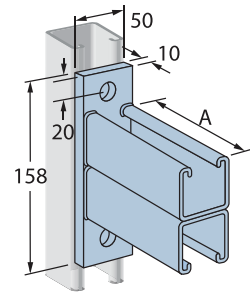

A	Design Uniform Load kg	Mass kg/100
305	741.86	228
460	511.56	314
610	390.04	400
760	314.58	487
915	261.66	574

F0075 - 0082

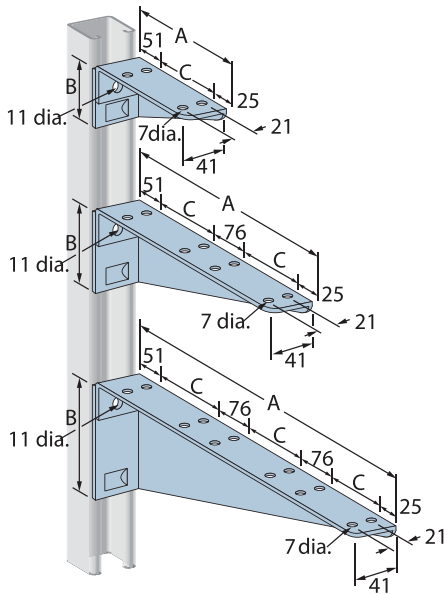

A	B	C	Design Uniform Load kg	Mass kg/100
152	56	76	153.86	30
152	56	76	153.86	30
305	87	76	134.26	69
305	87	76	134.26	69
457	125	152	98.98	121
457	125	152	98.98	121
610	164	127	96.40	182
610	164	127	96.40	182